



Product specification

Incubator IN75plus

The incubator I is at home everywhere in the world of research, medicine, pharmaceuticals and food analytics, as well as food chemistry.



The heating of this incubator is optimally tuned for natural convection and valuable chamber loads for research, pharmaceuticals, medicine and food chemistry are warmed up very carefully. On this page, you can find all the essential technical data on our incubator. Our customer relations team will be pleased to help if you want further information. If you should require a customised special solution, please contact our technical specialists at myAtmoSAFE@memmert.com.

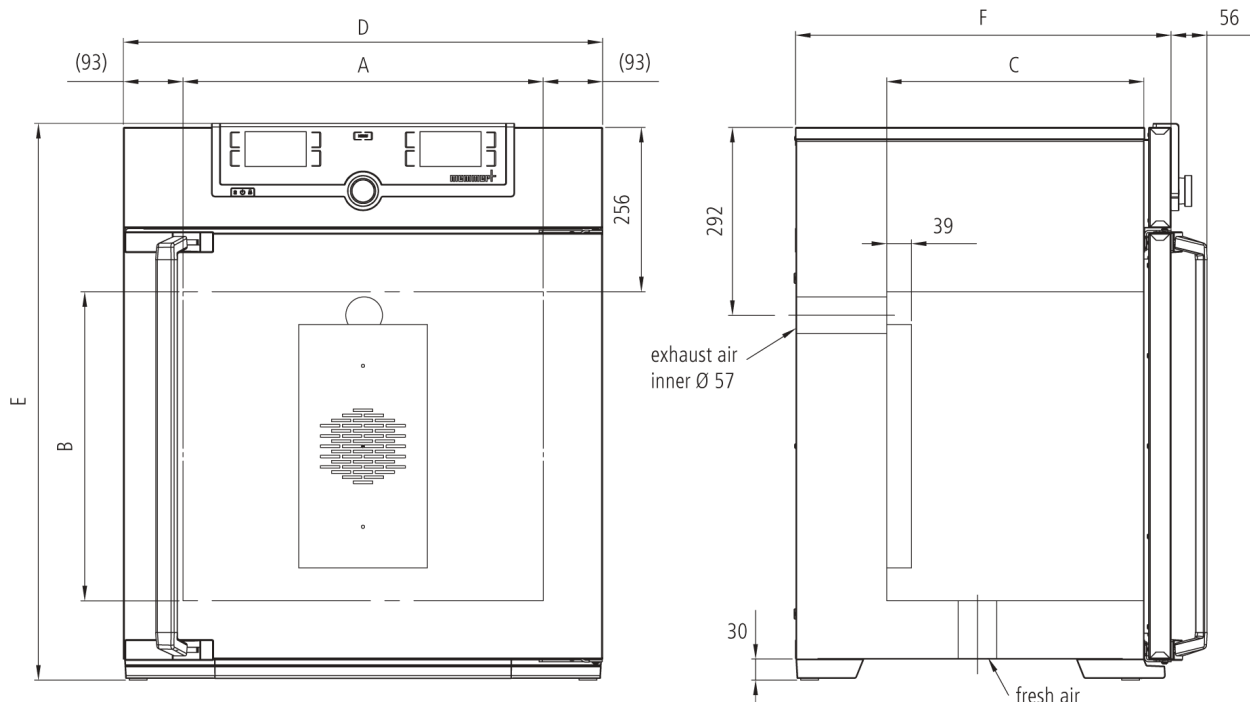

Temperature

Set temperature range in °C	min. 5°C above ambient up to +80°C
Setting accuracy temperature	0.1 °C
Temperature	2 Pt100 sensors DIN Class A in 4-wire-circuit for mutual monitoring, taking over functions in case of an error

Control technology

ControlCOCKPIT	TwinDISPLAY. Adaptive multifunctional digital PID-microprocessor controller with 2 high-definition TFT-colour displays.
Language setting	German, English, Spanish, French, Polish, Czech, Hungarian
Timer	Digital backwards counter with target time setting, adjustable from 1 minute to 99 days
Function HeatBALANCE	adapting the distribution of the heating performance of the upper and lower heating circuit from -50 % to +50 %
Function SetpointWAIT	the process time does not start until the set temperature is reached
Calibration	three freely selectable temperature values
adjustable parameters	temperature (Celsius or Fahrenheit), air flap position, programme time, time zones, summertime/wintertime
Sterilisation	fixed sterilisation programme (4 hours/160°C) for sterilisation of working chamber, not for sterilising the load

Ventilation

Convection	natural convection
Fresh air admixture	adjustment of pre-heated fresh air admixture by air flap control in 10 % steps for each segment individually
Vent	vent connection with restrictor flap

Communication

Documentation	programme stored in case of power failure
Programming	AtmoCONTROL software on a USB stick for programming, managing and transferring programmes via Ethernet interface or USB port

Safety

Temperature control	mechanical temperature limiter TB, protection class 1 according to DIN 12880 to switch off the heating approx. 20°C above nominal temperature
Temperature control	overtemperature monitor TWW, protection class 3.1 or adjustable temperature limiter TWB, protection class 2, selectable on display
AutoSAFETY	additionally integrated over- and undertemperature monitor "ASF", automatically following the setpoint value at a preset tolerance range, alarm in case of over- or undertemperature, heating is switched off in case of overtemperature
Autodiagnostic system	for fault analysis
Alarm	visual and acoustic

Standard equipment

Door	fully insulated stainless steel door with 2-point locking (compression door lock)
Internals	2 stainless steel grid(s), electropolished
Works calibration certificate	incl. works calibration certificate for +37°C
Door	inner glass door

Stainless steel interior

Interior	easy-to-clean interior, made of stainless steel, reinforced by deep drawn ribbing with integrated and protected large-area heating on four sides
Volume	74 l
Dimensions	$w_{(A)} \times h_{(B)} \times d_{(C)}$: 400 x 560 x 330 mm
Max. number of internals	6
Max. loading of chamber	120 kg
Max. loading per internal	20 kg

Textured stainless steel casing

Dimensions	$w_{(D)} \times h_{(E)} \times d_{(F)}$: 585 x 944 x 514 mm
Housing	rear zinc-plated steel

Electrical data

Voltage	230 V, 50/60 Hz
Electrical load	approx. 1250 W
Voltage	115 V, 50/60 Hz
Electrical load	approx. 900 W

Ambient conditions

Set Up	The distance between the wall and the rear of the appliance must be at least 15 cm. The clearance from the ceiling must not be less than 20 cm and the side clearance from walls or nearby appliances must not be less than 5 cm.
Altitude of installation	max. 2,000 m above sea level
Ambient temperature	+5 °C to +40 °C
Humidity rh	max. 80 %, non-condensing
Overvoltage category	II
Pollution degree	2

Packing/shipping data

Transport information	The appliances must be transported upright
Customs tariff number	8419 8998
Country of origin	Federal Republic of Germany
WEEE-Reg.-No.	DE 66812464
Dimensions approx incl. carton	w x h x d: 730 x 1130 x 670 mm
Net weight	approx. 66 kg
Gross weight carton	approx. 85 kg

Standard units are safety-approved and bear the test marks

